

Digital Video Processor

Operation Manual

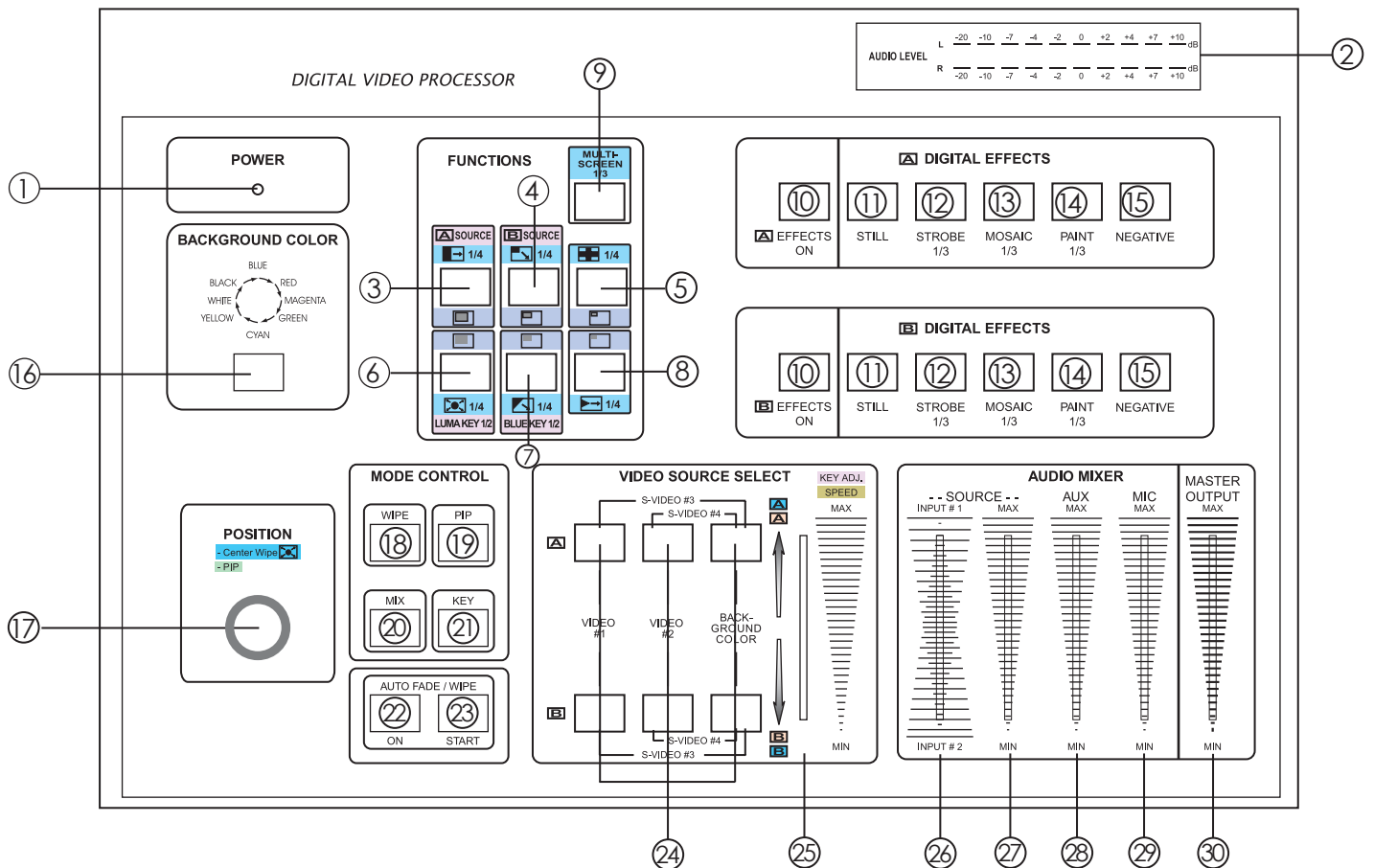

Control Panel Overview



Features

- Four Video Inputs-2 composite and 2 S-Video.
- Digital effects-STILL,STROBE,MOSAIC,PAINT,NEGATIVE.
- 96 wipe patterns.
- Chroma Key & Luminance Key.
- High resolution picture quality.
- 8 back colors.
- Joystick control for digital effect position.
- Fade control for Video and Audio.
- Audio and Video mixing.
- Picture in picture control.(3 window sizes)
- 2 Audio/Video and S-Video source inputs.
- 2 Audio/Video and S-Video source outputs.
- Auxiliary audio input.
- Microphone input and Headphone output.

Major Operating Controls and Their Functions

Power and Audio level indicator section

1. Power indicator.
2. Audio level indicator. (Audio level)
This indicator shows the audio output level of REC out 1 and REC out 2.

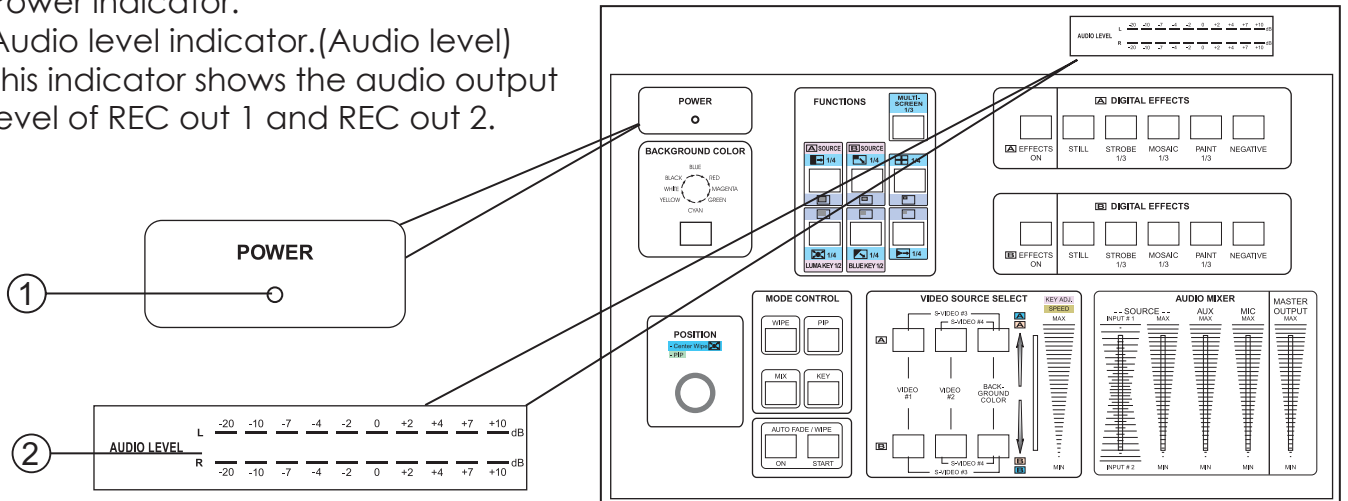

Wipe mode section

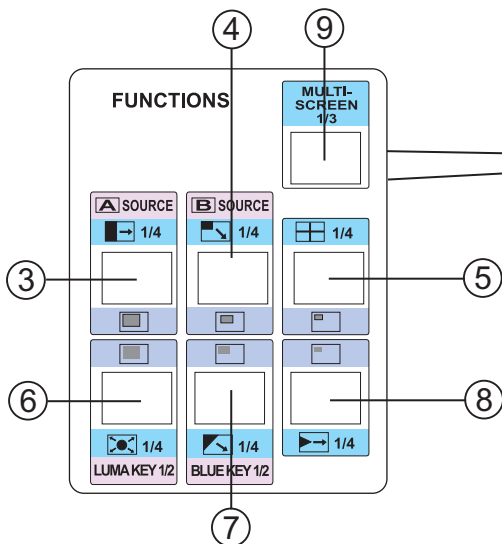

3. STRAIGHT wipe button.
4. CORNER wipe button.
5. SPLIT wipe button.
6. SQUARE wipe button.
7. DIAGONAL wipe button.
8. TRIANGLE wipe button.
9. MULTIPLE wipe button.

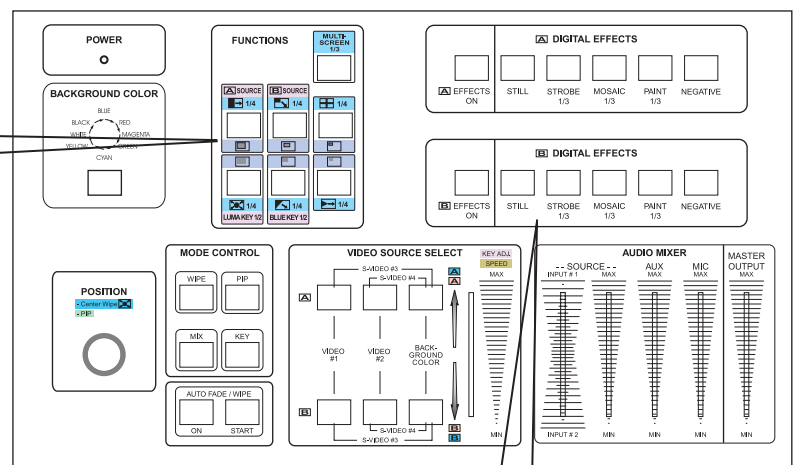

Digital effect section

10. **A**, **B**: A-bus, B-bus digital **ON** effect button.
11. STILL button.
12. STROBE button.
13. MOSAIC button.
14. PAINT button.
15. NEGA button.

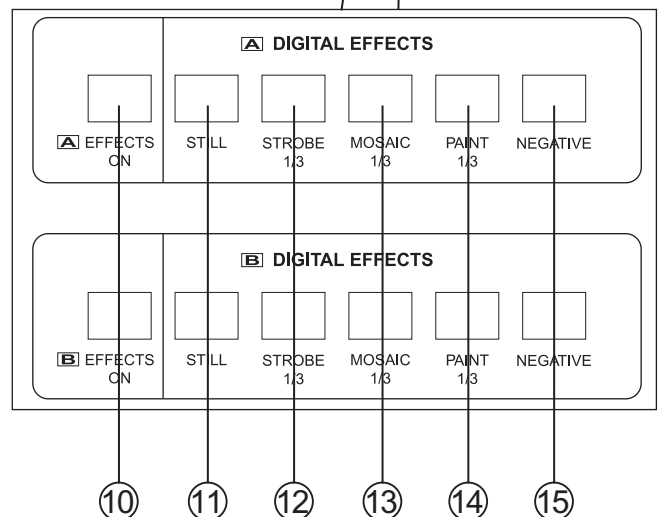

Major Operating Controls and Their Functions

■ Back color section

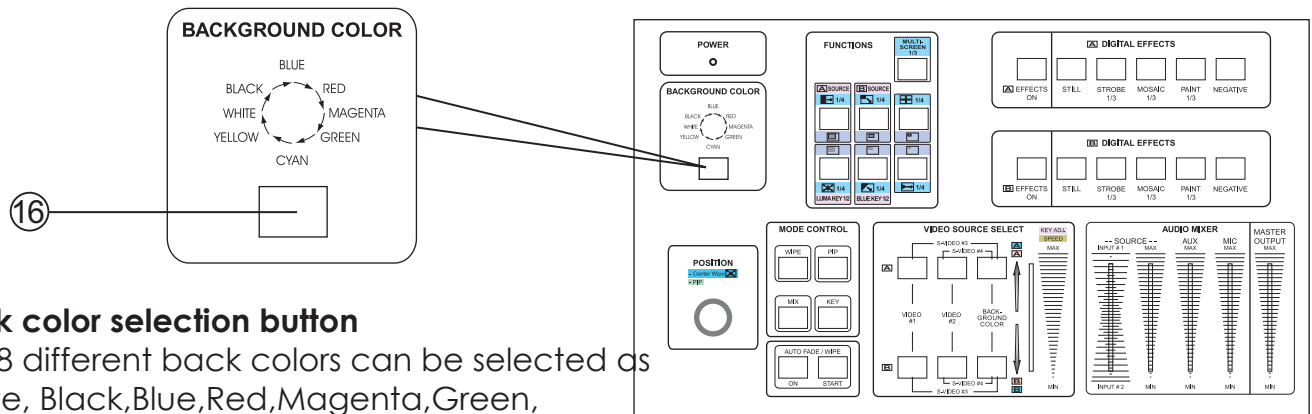

16. Back color selection button

8 different back colors can be selected as White, Black, Blue, Red, Magenta, Green, Cyan, Yellow.

■ Position section

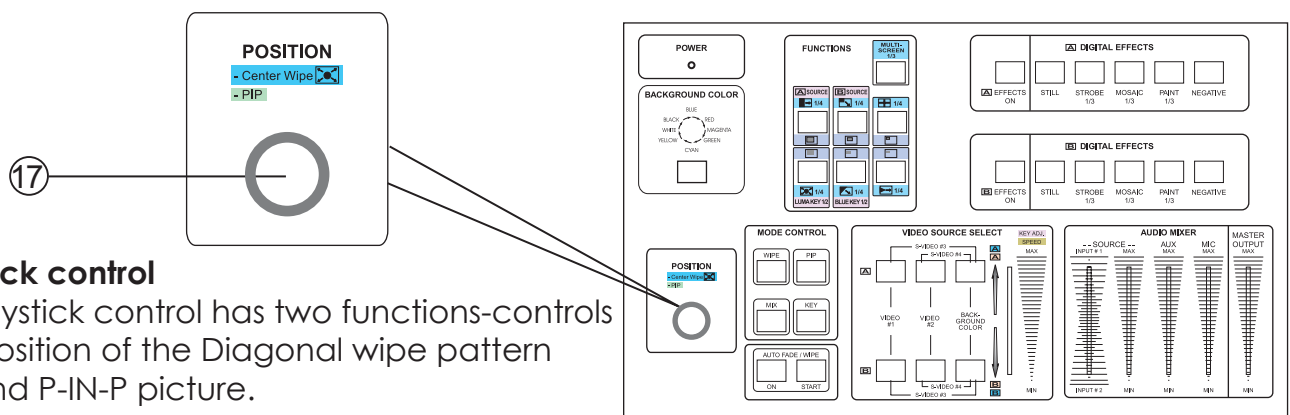

17. Joystick control

This joystick control has two functions-controls the position of the Diagonal wipe pattern (7) and P-IN-P picture.

■ Mode control section

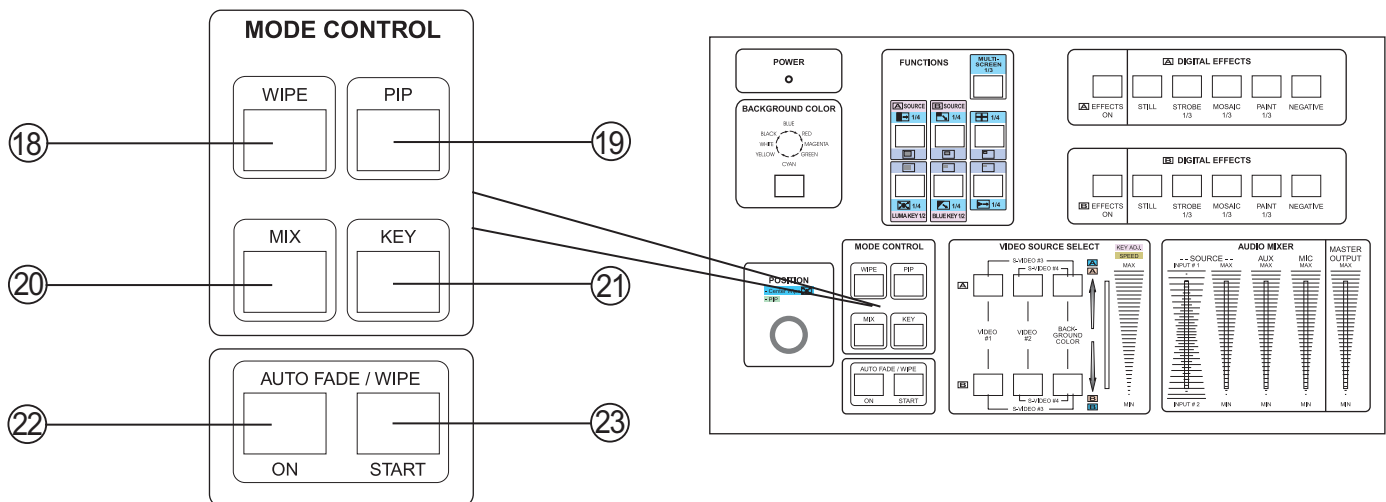

18. WIPE button: Press once to generate wipe edge (sharp edge).
Press again to remove wipe edge (soft edge).

19. PIP button: Picture in picture mode can be selected by pressing this button.

20. MIX (FADE) button: Press this button to select the fade In/Out mode; use slide bar (25) to fade from one source into another.

21. KEY button: This button allows you to tune in a best performance point for the blue key and luma key effects.

22. AUTO button: AUTO FADE/WIPE can be performed with START (23) button when this button (22) is set to ON.

23. START button: Automatic MIX and WIPE operation can be performed by pressing the START function. Transition time can be adjusted via video slide (25). When transition time lapsed, the LED goes off.

Major Operating Controls and Their Functions

■ Source select

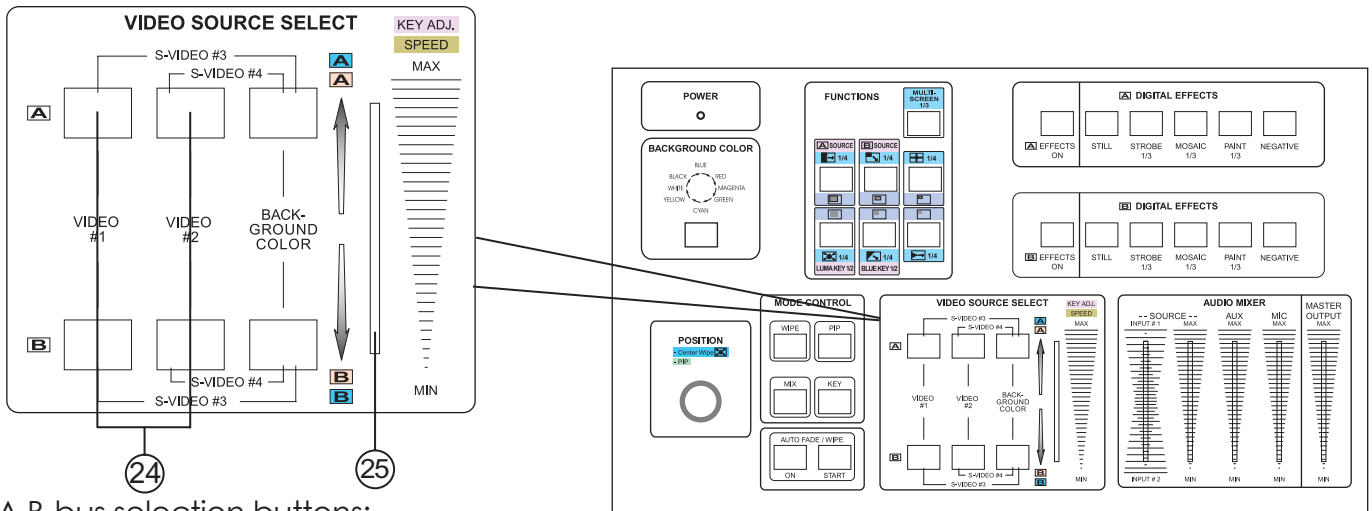

24. A,B-bus selection buttons:

This processor can connect up to 4 input sources, Video 1, Video 2, S-Video 3 and S-Video 4. These 4 sources along with 8 back-ground colors can be selected as A bus or B bus for performing Wipe, Mix, P-In-P and many other effects.

Press the left button alone allows you to select Video 1 source; press the center button alone you can select Video 2 source; press the right button alone allows you to select one of the eight back colors.

To select S-Video 3 and S-Video 4 source you need to program the Source Select into S- source mode by pressing both left and right buttons or both center and right buttons simultaneously. The former step will program the left button as S-Video 3 while the latter will program the center button as S-Video 4.

After programed into S mode, press left button alone will allow you to select S-Video 3; press the center button alone you'll get S-Video 4.

To exit S-sources mode and re-enter into video sources mode, you need to press again both left and right buttons or both center and right buttons simultaneously.

You can program both buttons into S-mode or program one button into S mode while keep the other at video source mode.

The same procedure apply to both A and B-bus.

25. VIDEO slide: Wipe, PIP and Key effects could be controlled by this Video slide which moves A/B bus outputs horizontally or vertically,

■ AUDIO MIXER Section

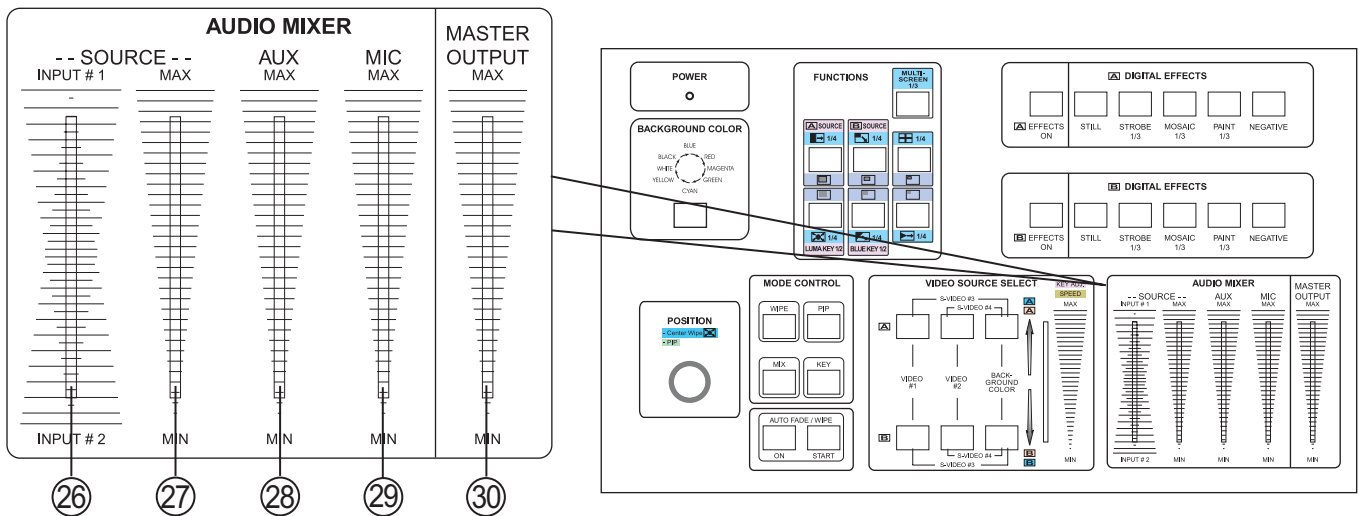

26. AUDIO : This slide dissolves the audio from Source A to Source B when the slide is moved from the top to the bottom.

27. SOURCE : This slide controls the audio level of the Source selected with slide 26.

28. AUX: Controls the audio level of the Auxiliary input.

29. MIC: Controls the audio level of the microphone input.

30. MASTER: Controls the overall audio output level.

Major Operating Controls and Their Functions

FRONT PANEL

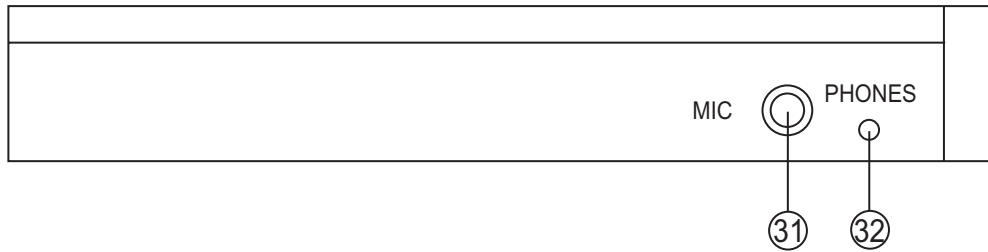

- 31. MIC : Microphone Jack.
- 32. PHONES : Headphone Jack.

REAR PANEL

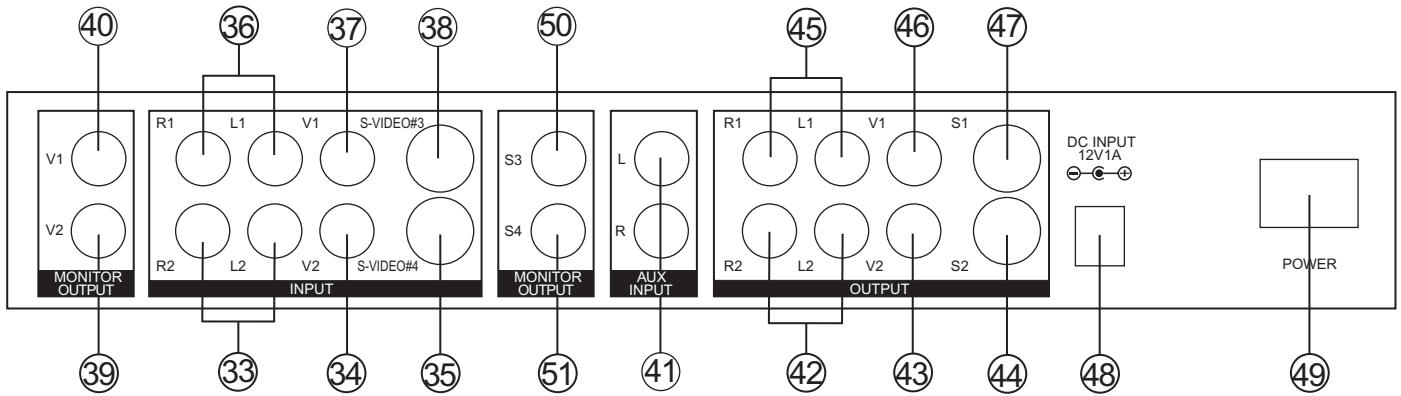

- 33. Source 2 Audio input Jack.
- 34. Source Video-2 input Jack.
- 35. Source S-VIDEO#4 input connector.
- 36. Source 1 Audio input Jack.
- 37. Source Video-1 input Jack.
- 38. Source S-VIDEO#3 input Jack.
- 39. Source V2 monitor output Jack.
- 40. Source V1 monitor output Jack.
- 41. Auxiliary Audio input Jack.
- 42. Recording out 2 Audio output Jack.
- 43. Recording out 2 Composite video output Jack.
- 44. Recording out 2 S-Video output Jack.
- 45. Recording out 1 Audio output Jack.
- 46. Recording out 1 Composite video output Jack.
- 47. Recording out 1 S-Video output Jack.
- 48. DC INPUT 12V 1A.
- 49. POWER On/Off.
- 50. Source S3 monitor output.
- 51. Source S4 monitor output.

Basic Operations

Press the power switch on the rear panel to the ON Position. The LED's on the operation panel light up and the unit is now in initial mode for operation.

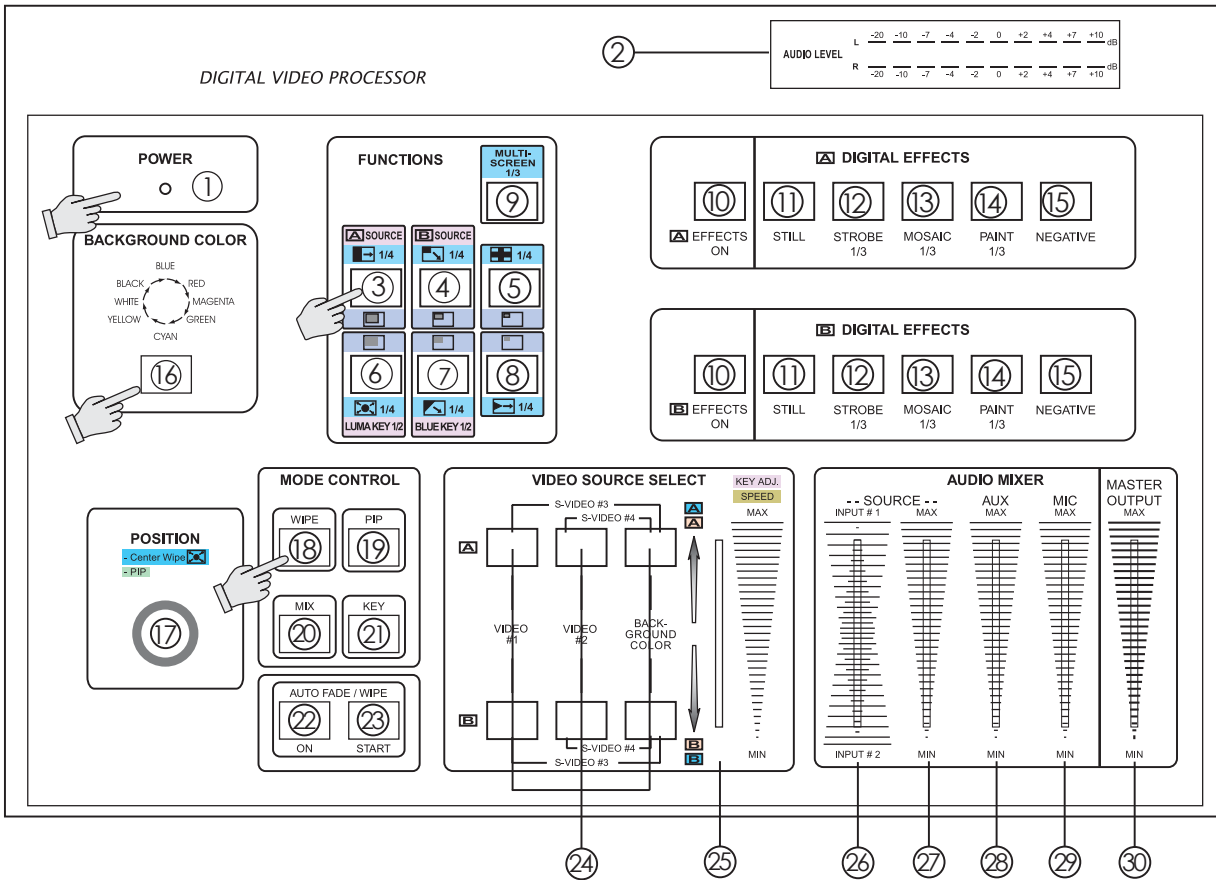

A. Input signal selection and Back color Selection

1. Slide the Video slide (25) to the A-bus position.
2. Press any of the Source 1 or Source 2 button. You will see the corresponding picture on the screen.
3. Press a Back Color button to select the back color you need.
4. Any of the 8 Back Colors-Blue→Red→Magenta→Green→Cyan→Yellow→White→Black, can be selected by repeatedly pressing the Back color selection button (16).

* Please refer to Source select 24 in page 4 for selecting input sources from Video 1, Video 2, S-Video 3, and S-Video 4.

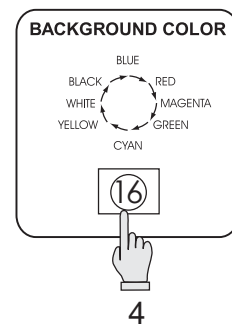
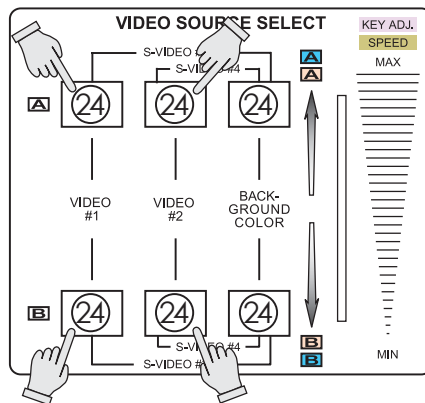
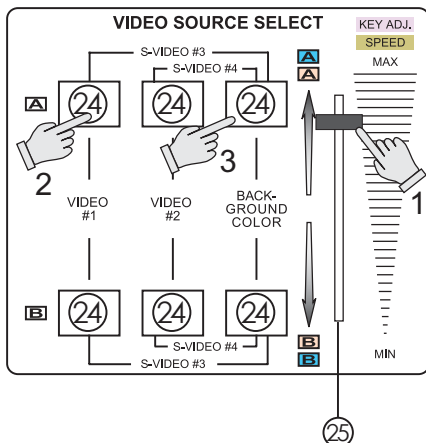

Basic Operations

B. VIDEO MIX

Reset the operation panel to initial mode:

1. Press the MIX button (20).
2. Press one of the A-bus selection buttons.
3. Press one of the B-bus selection buttons.
4. Mix effect could be controlled by Video slide (25) which sliding A to B or B to A.

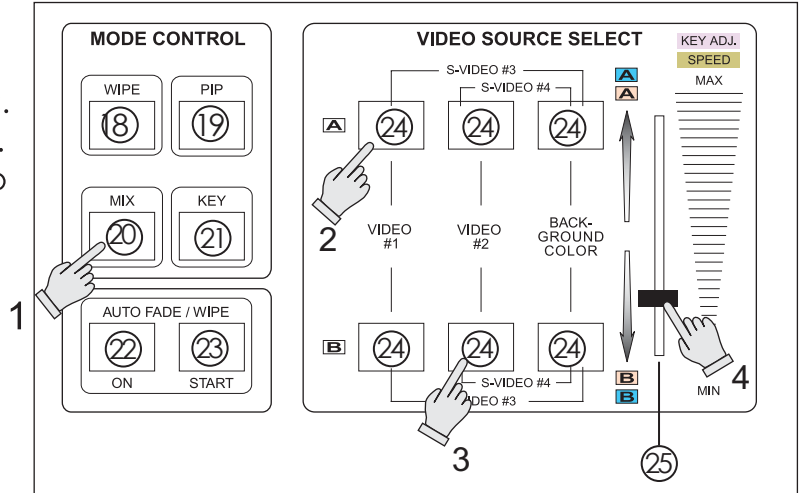

C. VIDEO WIPE

Reset the operation panel to initial mode:

1. Each depression of the button results in a change on the wipe edge. The sequence of selection is: Sharp edge → Soft edge.
2. Press one of the A-bus selection button.
3. Press one of the B-bus selection button.
4. Wipe effect could be controlled by Video slide (25) which moves A/B bus outputs horizontally or vertically.

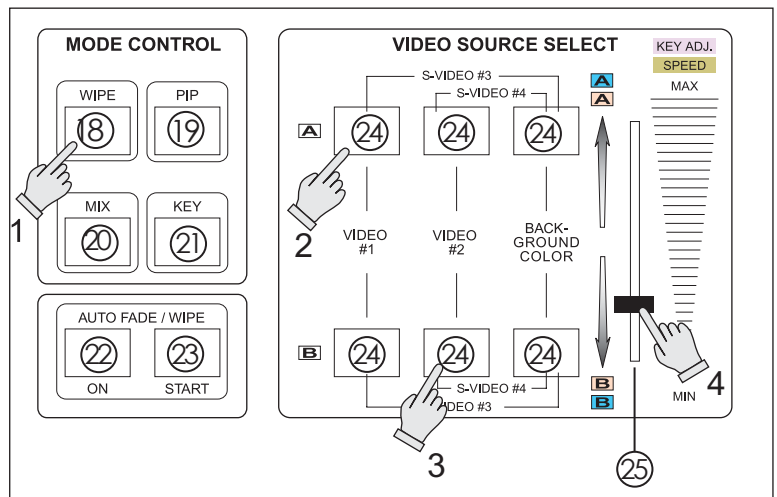

C. VIDEO WIPE

■ WIPE PATTERN selection:

Six wipe modes can be selected as follows:

1. Press the straight wipe button (3) repeatedly, Four patterns are available.

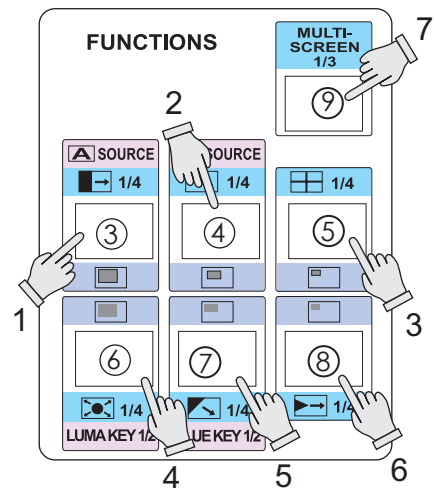
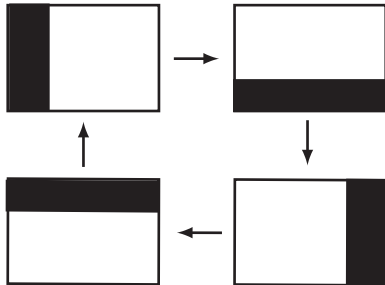

2. Press the corner wipe button (4) repeatedly, Four patterns are available.

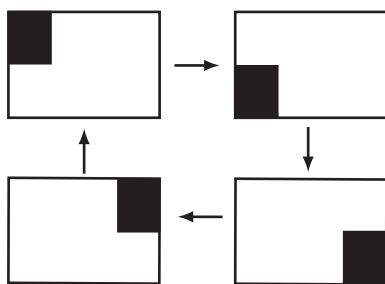

5. Press the diagonal wipe button (7) repeatedly, Four patterns are available.

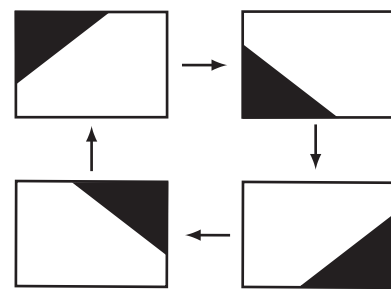

3. Press the split wipe button (5) repeatedly, Four patterns are available.

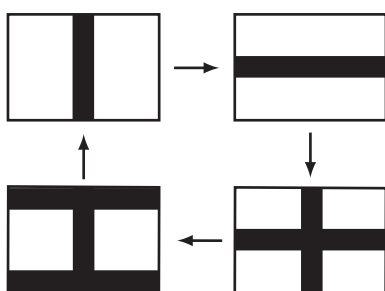

6. Press the triangle wipe button (8) repeatedly, Four patterns are available.

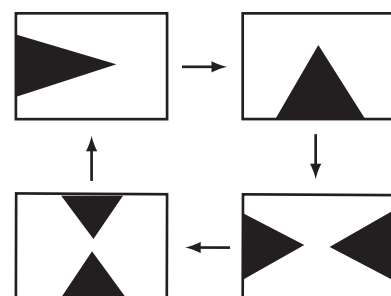

4. Press the square wipe button (6) repeatedly. Four patterns below are available. Each pattern position in this section could be set by joystick (17).

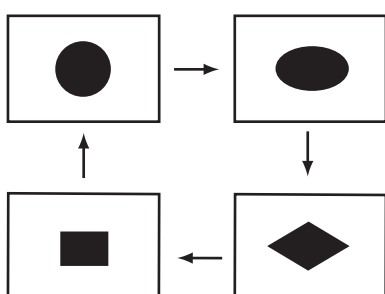

C. VIDEO WIPE

■ **MULTIPLE WIPE selections:**

1. Press the wipe button (18).
2. Press the straight wipe button (3) for example.
3. Press the multi (9) button repeatedly to have the desired multiplication.
Four patterns are available.
4. Press one of the A-bus selection button.
5. Press one of the B-bus selection button.
6. Operate the video slide (25).

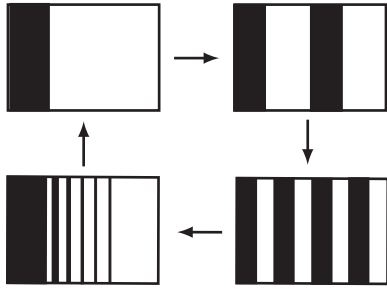

* The same procedures apply to other patterns.

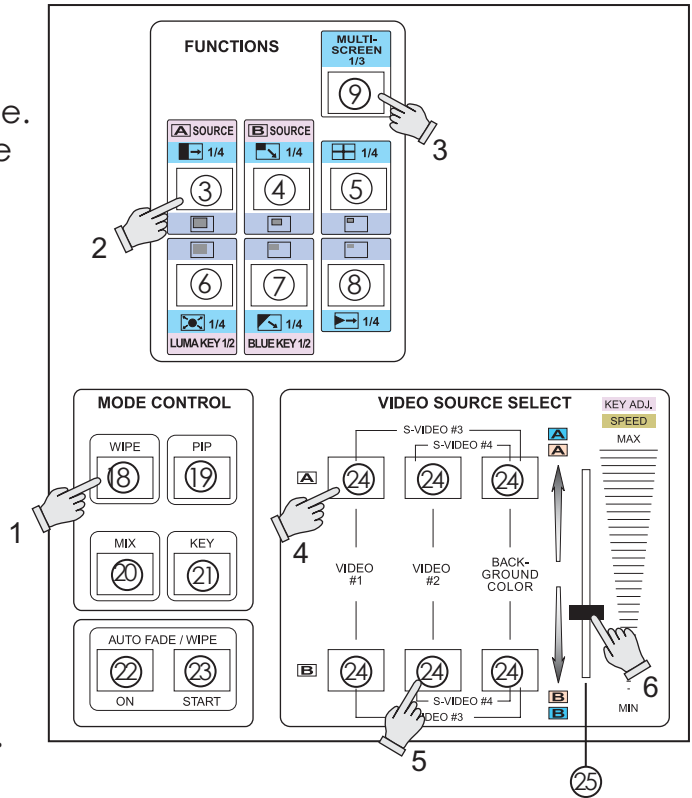

D. P-IN-P

Press the operation panel to initial mode:

1. Slide the video slide fully to the B-bus position.
2. Press one of the A-bus selection button.
3. Press one of the B-bus selection button.
4. Press the PIP button (19).

- PIP mode changes by selecting (3) ~ (8) buttons.
3. 1/2 — Shows sub-picture in 1/2 size with edge.
 4. 1/3 — Shows sub-picture in 1/3 size with edge.
 5. 1/4 — Shows sub-picture in 1/4 size with edge.
 6. 1/2 — Shows sub-picture in 1/2 size without edge.
 7. 1/3 — Shows sub-picture in 1/2 size without edge.
 8. 1/4 — Shows sub-picture in 1/2 size without edge.

5. Other PIP features:

1. 3 PIP sizes selectable for sub-picture PIP channel.
2. The color of the edge can be changed by pressing back color select button (16).
3. When you slide the video slide (25) to the A-bus position PIP picture dissolves into back ground scene.
4. Sub-picture PIP channel may be placed into different positions by Joystick (17).

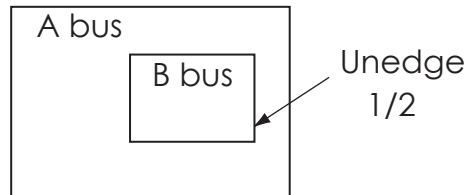
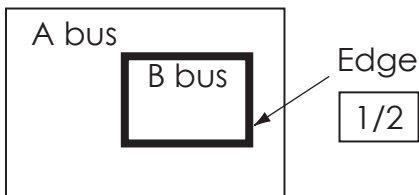
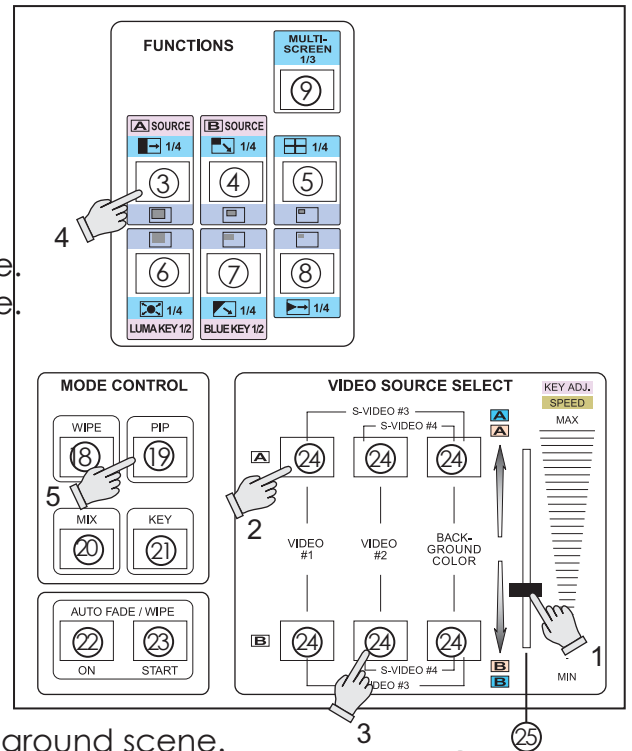

E. KEY

Reset the operation panel to initial mode:

- How to use the Luma key effect:
 1. Press the KEY button (21).
 2. Press one of the A-bus selection button.
 3. Press one of the B-bus selection button.
 4. Press the LUMA KEY button (6).
 5. Use slide bar to control the Luma key level.
 6. Press button (3) or (4) to change the source that is being keyed.

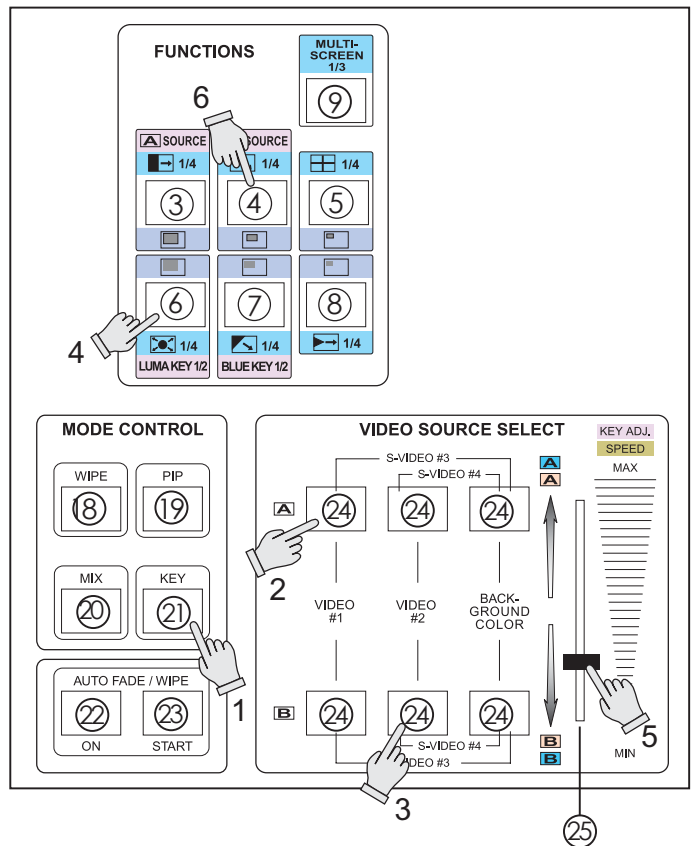

- How to use the Blue key effect:
 1. Press the KEY button (21).
 2. Press one of the A-bus selection button.
 3. Press one of the B-bus selection button.
 4. Press the BLUE KEY button (7).
 5. Use slide bar to control Blue key level.
 6. Press button (3) or (4) to change the source that is being keyed.

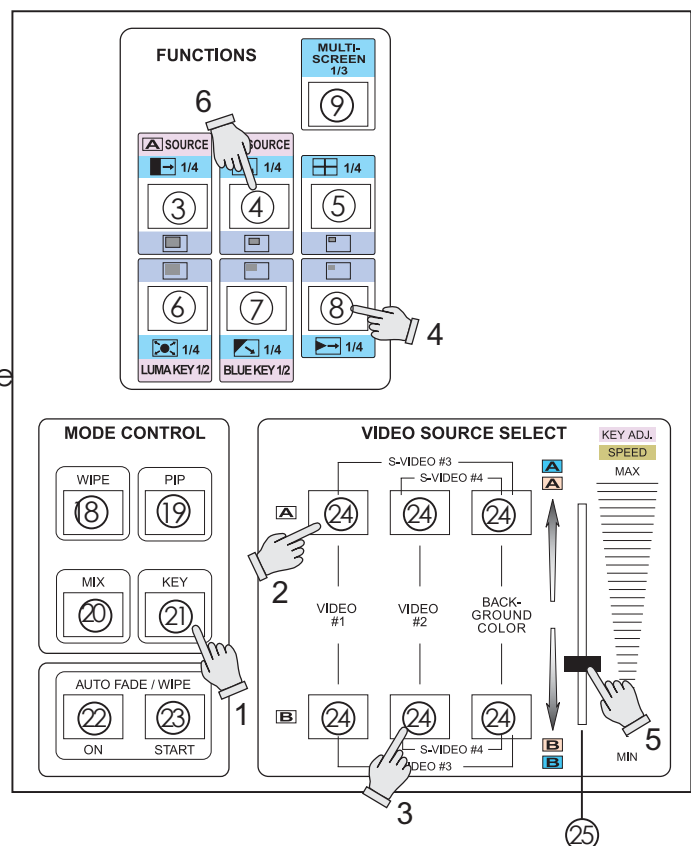

Basic Operations

F. AUTO FADE/WIPE selection

Reset the operation panel to initial mode:

1. Press the ON button (22) to enter into AUTO FADE/WIPE mode.
2. FADE/WIPE transition time can be adjusted by operating slide bar (25).
3. Press the WIPE button (18) for wipe effect.
4. Press the MIX button (20) for mix(fade) effect.
5. Press the START button (23) to start Auto wipe or fade effect.

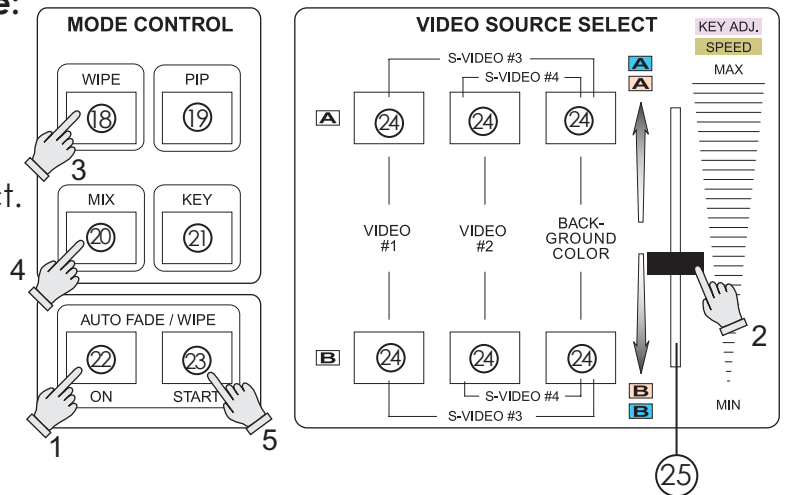

G. DIGITAL EFFECT

- Digital effect section which generates digital special effects for the A bus and B-bus source video signals. The selected effect(s) can be added to either the A-bus or B-bus at one time.
 - The mosaic effects is not available in sub-picture under PIP mode.
10. **A**, **B** : A-bus, B-bus digital effect **ON** button.
 11. STILL button.
 12. STROBE button - 3 steps.
 13. MOSAIC button - 3 steps.
 14. PAINT button - 3 steps.
 15. NEGATIVE button.

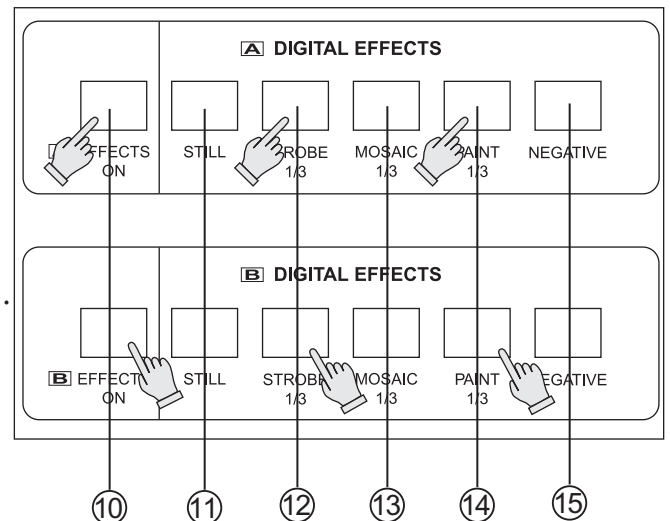

H. AUDIO MIXER

- Audio can be processed either separately or in combination with a video source.
26. AUDIO: This slide dissolves the audio from source A to Source B when the slide is moved from the top to the button.
 27. SOURCE: This slide controls the audio level of the source selected with slide (26). If 26 is at the top, source A, then the level input of source A can be reduced with this slide.
 28. AUX: Controls the audio level of the auxiliary input.
 29. MIC: Controls the audio level of the microphone input.
 30. MASTER: Controls the overall audio output level.

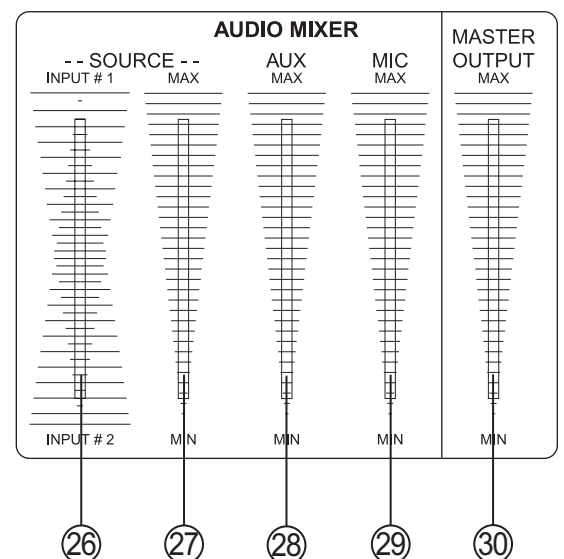

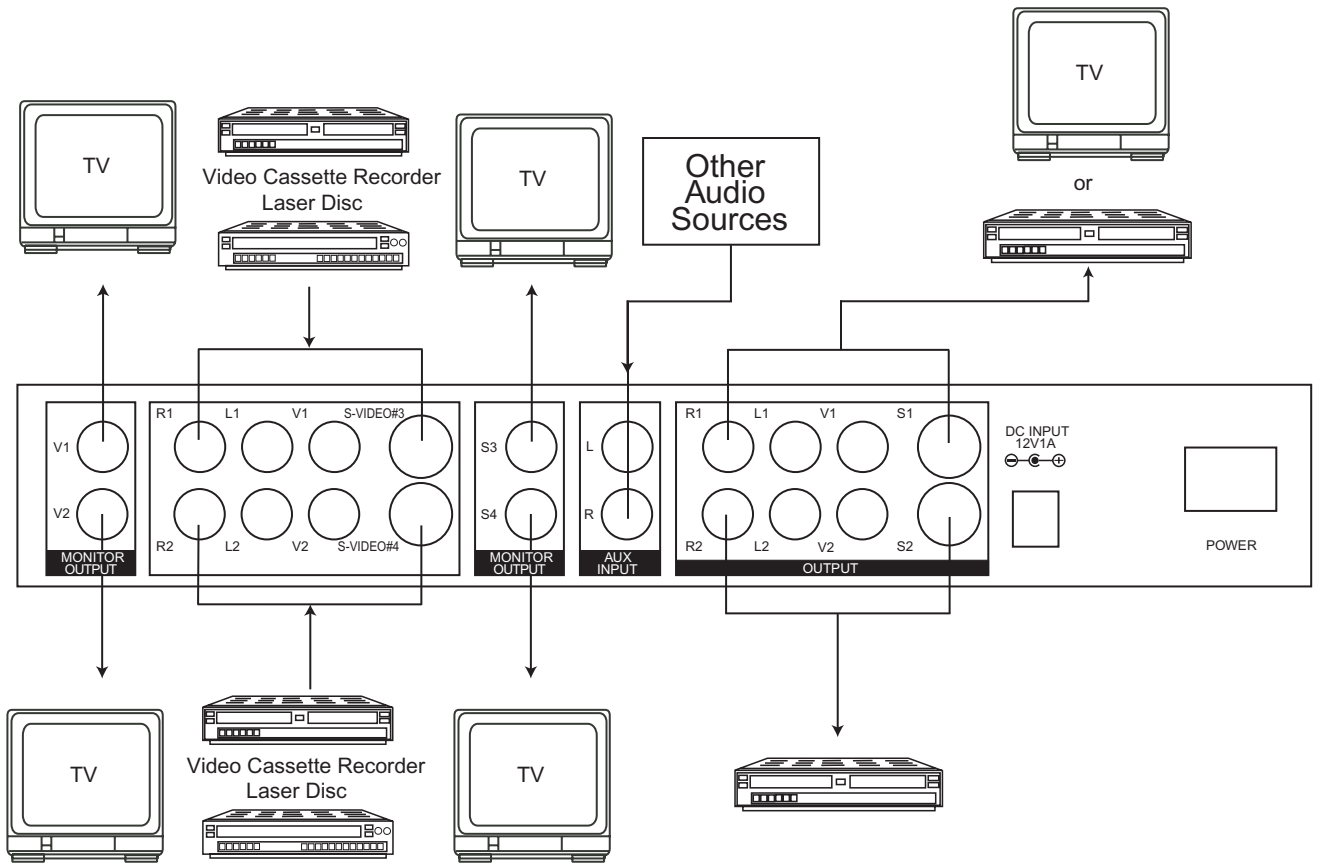

Specifications

Source Input	<p>x 4 (Source 1, 2, 3, 4)</p> <p>Video input: 1.0 Vp-p 75 Ω NTSC (PAL) composite signal, Pin-Jack</p> <p>Y/C input: Y signal: 1.0 Vp-p 75Ω, Mini Din 4-pin connector C signal: 0.3 Vp-p 75Ω, Mini Din 4-pin connector</p> <p>Audio input: -6 dBs/20 kΩ Pin Jack (L/R).</p>
External Sound Input	<p>MIC input: x 1 (MIC); -60 dBv/600 Ω</p> <p>AUX input: x 1 (AUX); -6 dBs/20 kΩ, Pin Jacks(L/R)</p>
Recording Output	<p>x 2 (Video out 1,2)</p> <p>Video output: 1.0 Vp-p 75 Ω NTSC (PAL) composite signal, Pin-Jacks</p> <p>Y/C output: Y signal: 1.0 Vp-p 75 Ω C signal: 0.3 Vp-p 75 Ω, Mini Pin 4-pin connector</p> <p>Audio output: -6 dBs/ 1 kΩ Pin Jacks(L/R)</p>
Monitor Output	<p>x 4 (monitor out)</p> <p>video output: 1.0 Vp-p 75 Ω composite signal, Pin-Jacks</p>
Headphone Output	x 1 (Headphone); -20 dBv~ -80 dBv, 8 Ω unbalance, phone-5 jack
Effects	<p>Video: Still, Strobe, Mosaic, Paint, Negative, Wipe, Mix, Fade, Picture-In-Picture, Chroma key, Luminance key</p>
Back Color	White, Yellow, Cyan, Green, Magenta, Red, Blue, Black
Wipe Patterns	96 patterns
S/N (Typical)	video: 48 dB (composite), 50 dB (Y/C) Audio: 60 dB
Power Source	12V DC
Power Consumption	Approx. 15W
Dimensions	400(W) x 300(D) x 55(H) mm
Weight	2.5 Kgs